

Electrodo de disco

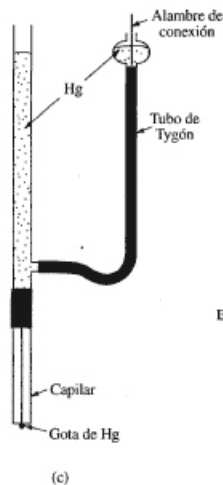

Electrodo de gota colgante de Hg



Electrodo de gotas de Hg

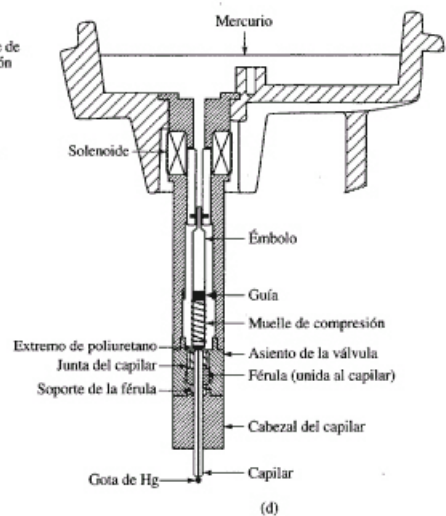

Electrodo de gota estática de Hg

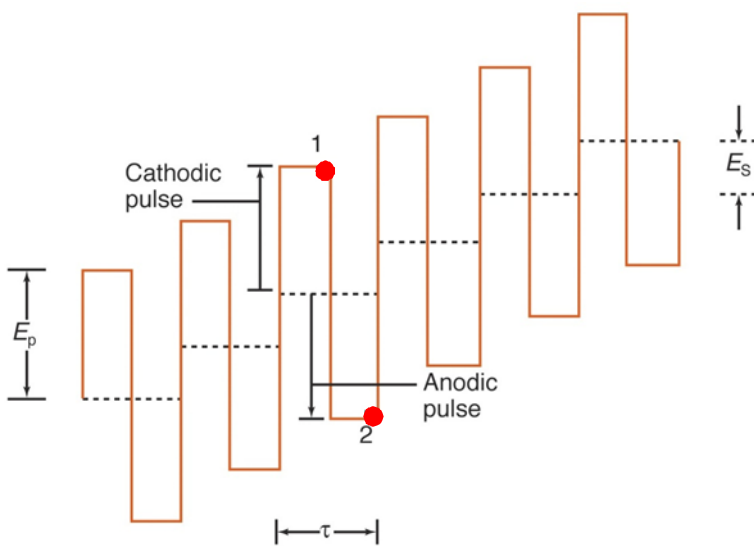
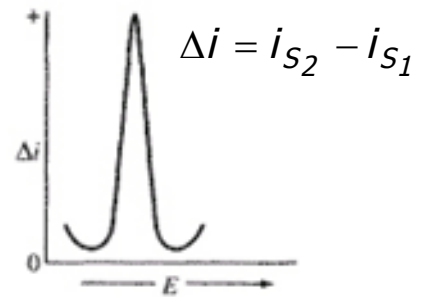
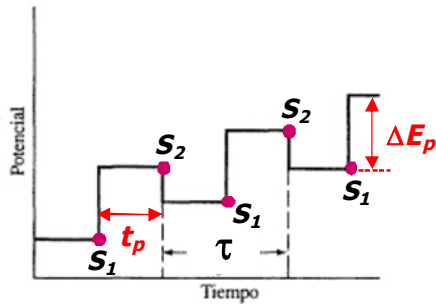
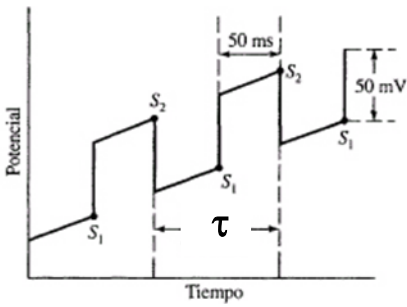
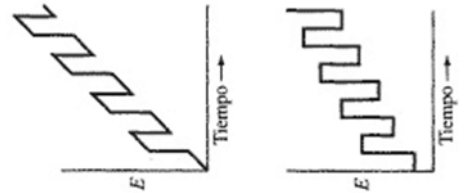
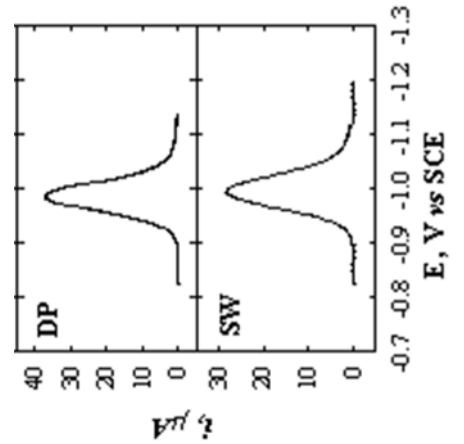
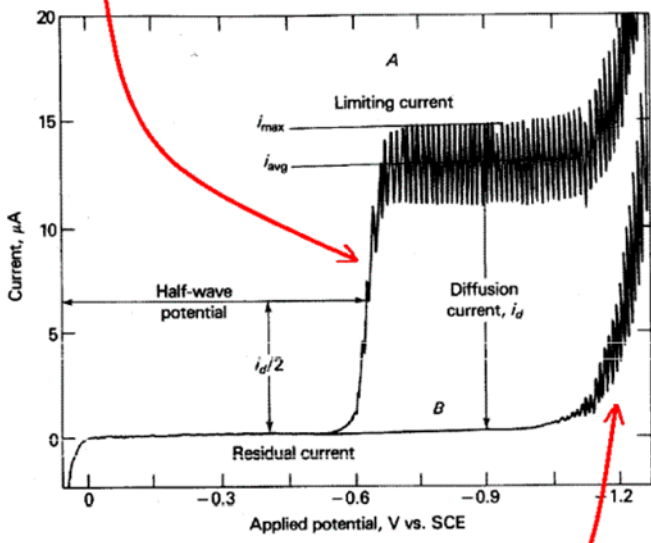
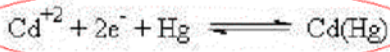

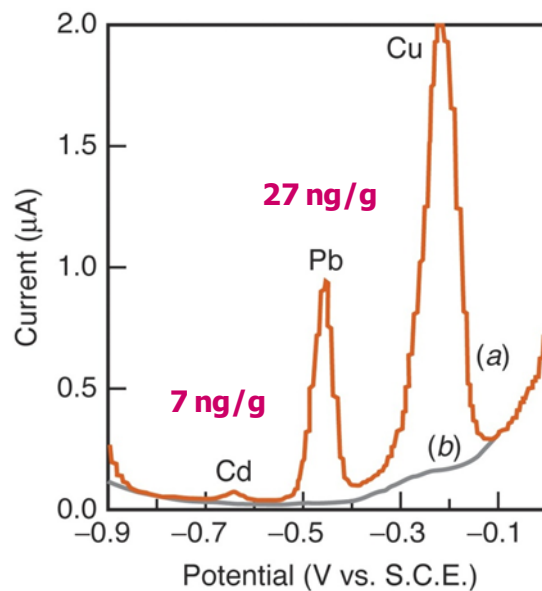
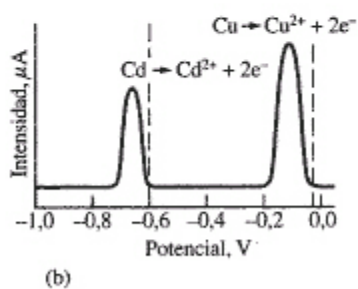
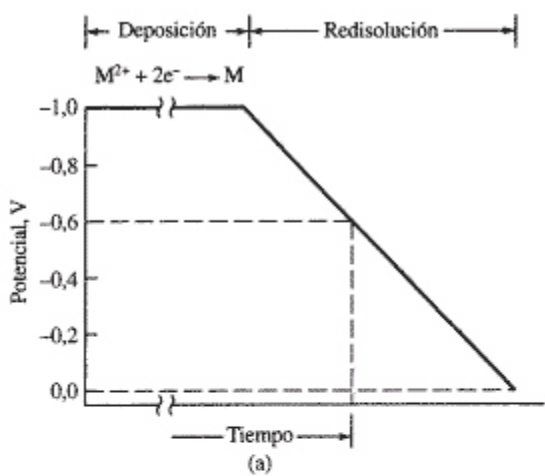
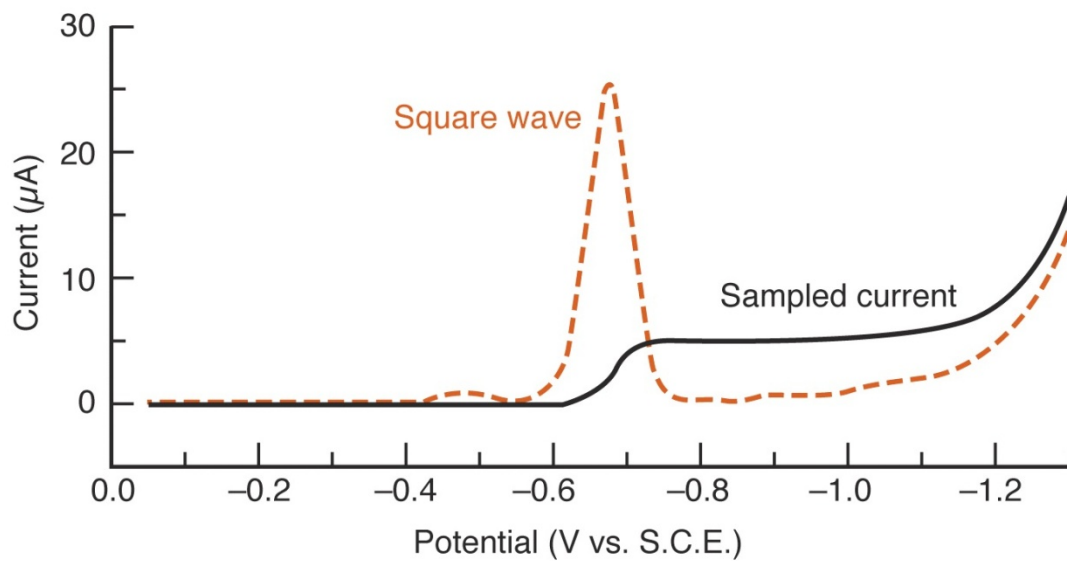

Figura 25-32. (a) Señal de excitación para la determinación por redisolución de Cd^{2+} y Cu^{2+} . (b) Voltamperograma de redisolución.